

# PARTS LIST

[ KS-FX915R ]  
[ KS-FX815 ]

\* All printed circuit boards and its assemblies are not available as service parts.

Area suffix

EE ----- Russian Federation

## - Contents -

Exploded view of general assembly and parts list .....	3- 2
Cassette mechanism assembly and parts list .....	3- 5
Electrical parts list .....	3-10
Packing materials and accessories parts list .....	3-16

# Exploded view of general assembly and parts list

Block No. M 1 M M

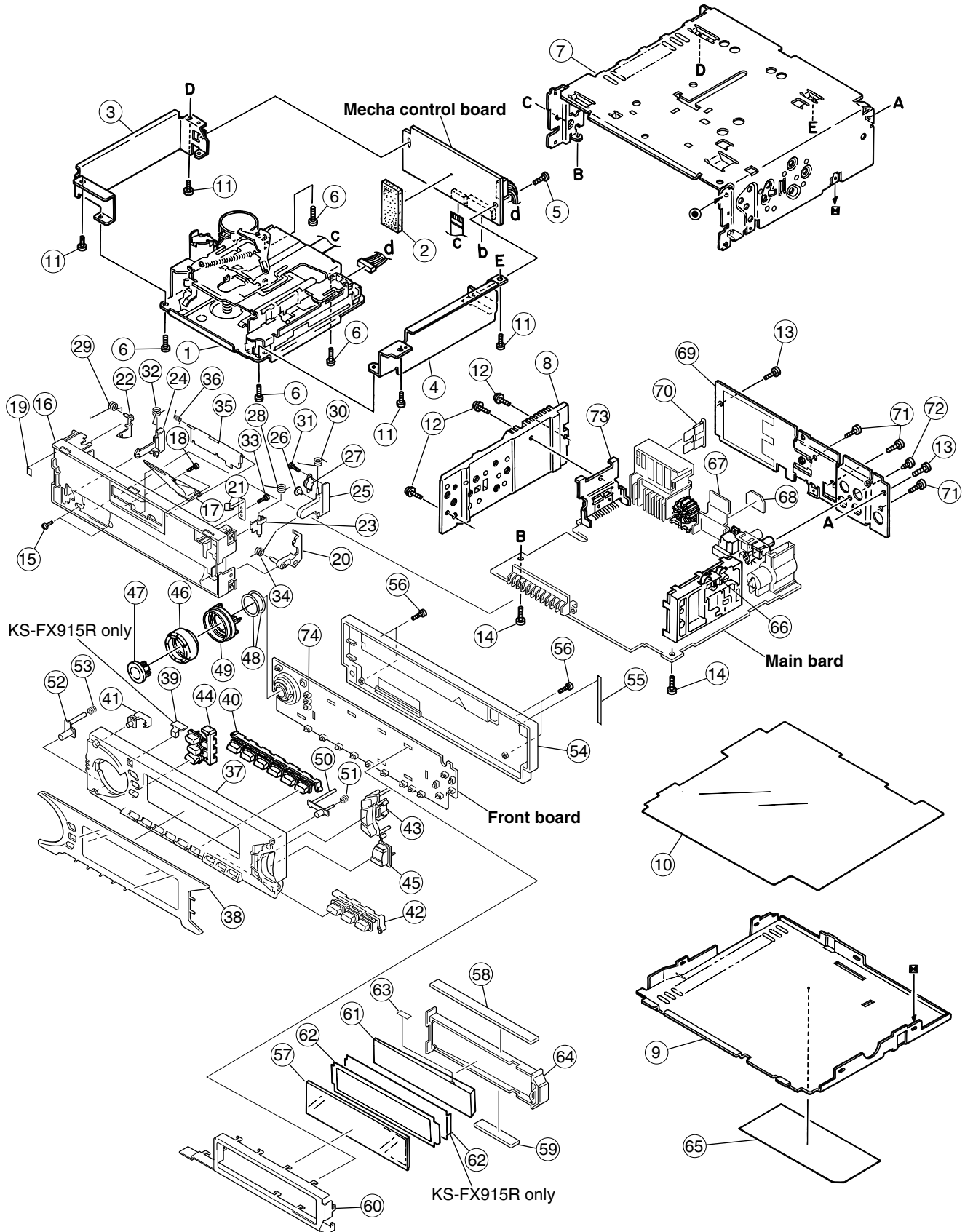

■ Parts list(General assembly)

Block No. M1MM

△	Item	Parts number	Parts name	Q'ty	Description	Area
	1	-----	CDS-801 JV2	1		
	2	FSYH4036-050	SHEET	1		
	3	FSKL2001-002	MECHA BRACKET(L	1		
	4	FSKL2002-001	MECHA BRACKET(R	1		
	5	QYSDST2606Z	SCREW	1		
	6	QYSDST2606Z	SCREW	4		
	7	FSJC1056-002	TOP CHASSIS	1		
	8	FSMH3001-204	HEAT SINK	1		
	9	FSKM3011-002	BOTTOM COVER	1		
	10	FSMA3005-001	INSULATOR	1		
	11	QYSDST2604Z	SCREW	4	CHASSIS+MECHA.B	
	12	FSKZ4005-001	SCREW	3	CHASSIS+SIDE PA	
	13	QYSDST2604Z	SCREW	2	CHASSIS+REAR BKT	
	14	QYSDST2606Z	SCREW	2	CHASSIS+MAIN PWB	
	15	QYSDSF2006M	SCREW	2	F.CHASSIS+CONECTOR	
	16	FSJC1060-002	FRONT CHASSIS	1		
	17	VJK3707-001	LIGHT LENS	1		
	18	QYSPSGU1745N	MINI SCREW	2	FOR LIGHT LENS	
	19	FSYH4036-046	SHEET	1		
	20	FSKS3014-001	OPEN LEVER	1		
	21	FSKS3015-001	LOCK LEVER(O.L)	1		
	22	VKS3798-002	RELEASE LEVER	1		
	23	VKS3793-001	LOCK LEVER(TOP)	1		
	24	VKS3794-003	LOCK LEVER(L)	1		
	25	VKS3795-002	LOCK LEVER(R)	1		
	26	VKS5563-001	GEAR	1		
	27	VKZ4786-002	OIL DAMPER	1		
	28	FSKW4012-001	T.SPRING	1	FOR L.LEVER(TOP)	
	29	VKW5264-005	T.SPRING	1	FOR RELEASE LEVER	
	30	VKW5262-001	T.SPRING	1	FOR L.LEVER(R)	
	31	QYSDSF2006M	SCREW	1	DAMPER+L.LEVER	
	32	VKW5263-002	T.SPRING	1	FOR L.LEVER(L)	
	33	VKZ4777-001	MINI SCREW	1	LOCK LEVER(O.L.)	
	34	FSKW4013-002	T.SPRING	1	FOR OPEN LEVER	
	35	FSJC3014-001	CASSETTE LID	1	NO PRINTING	
	36	VKW4947-002	DOOR SPRING	1		
	37	GE10005-001B	FRONT PANEL	1		
	38	GE30113-012B	FINDER LENS	1	KS-FX915R	
		GE30113-013A	FINDER LENS	1	KS-FX815	
	39	FSJK4009-001	REMOTE LENS	1	KS-FX915R	
	40	GE20104-001B	PRESET BUTTON	1	1-6 (2 COLOUR)	
	41	GE30105-002B	POWER BUTTON	1		
	42	GE30106-001A	SND FUNC BUTTON	1	RPT,RND,SCM	
	43	GE20110-001C	D.FUNCTION BTN	1	TAPE,F/A,CD-CH	
	44	GE20103-001A	PUSH BUTTON(3)	1		
	45	GE20109-001C	UP DOWN BUTTON	1		
	46	GE30103-001B	KNOB	1	JOG DIAL	
	47	GE30102-002A	SEL BUTTON	1		

**■ Parts list(General assembly)**

Block No. M1MM

△	Item	Parts number	Parts name	Q'ty	Description	Area
	48	LV40833-001A	SPACER	2		
	49	GE30104-001A	RIM LENS	1	FOR KNOB	
	50	GE30115-002A	EJECT BUTTON	1		
	51	VKW3001-330	COMP.SPRING	1	FOR EJECT BUTTON	
	52	GE30116-001A	DETACH BUTTON	1		
	53	VKW3001-330	COMP.SPRING	1	FOR DETACH BUTTON	
	54	GE10006-001A	REAR COVER	1		
	55	FSYH4036-035	SHEET	1	REAR COVER	
	56	VKZ4777-001	MINI SCREW	4	FRONT+REAR	
	57	QLD0163-001	LCD MODULE	1	KD-FX915R	
		QLD0164-001	LCD MODULE	1	KD-FX815	
	58	QNZ0449-001	RUBBER CONNECTO	1		
	59	QNZ0450-001	RUBBER CONNECTO	1		
	60	GE30114-001A	LCD CASE	1		
	61	FSJK3028-001	LCD LENS	1		
	62	FSYH4061-001	LIGHTNG SHEET	1	KD-FX815	
		FSYH4061-001	LIGHTNG SHEET	2	KD-FX915R	
	63	FSYH4036-052	SHEET	1		
	64	FSKS3013-001	LENS CASE	1		
	65	GE30148-002B	NAME PLATE	1	KD-FX815	
		GE30149-002B	NAME PLATE	1	KD-FX915R	
	66	VMA4652-001SS	EARTH PLATE	1		
	67	GE40103-001A	REGULAT.BRACKET	1		
	68	GE40104-002B	HEAT SINK	1		
	69	FSKM3012-014	REAR BRACKET	1		
△	70	QMFZ047-150-T	FUSE	1		
	71	QYSDST2606Z	SCREW	3	REAR BKT+ANT JACK	
	72	QYSDSF3006Z	SCREW	1	REAR BKT+PIN JACK	
	73	FSKL4024-001	IC BRACKET	1		
	74	FSKS3017-002	LED HOLDER	1		



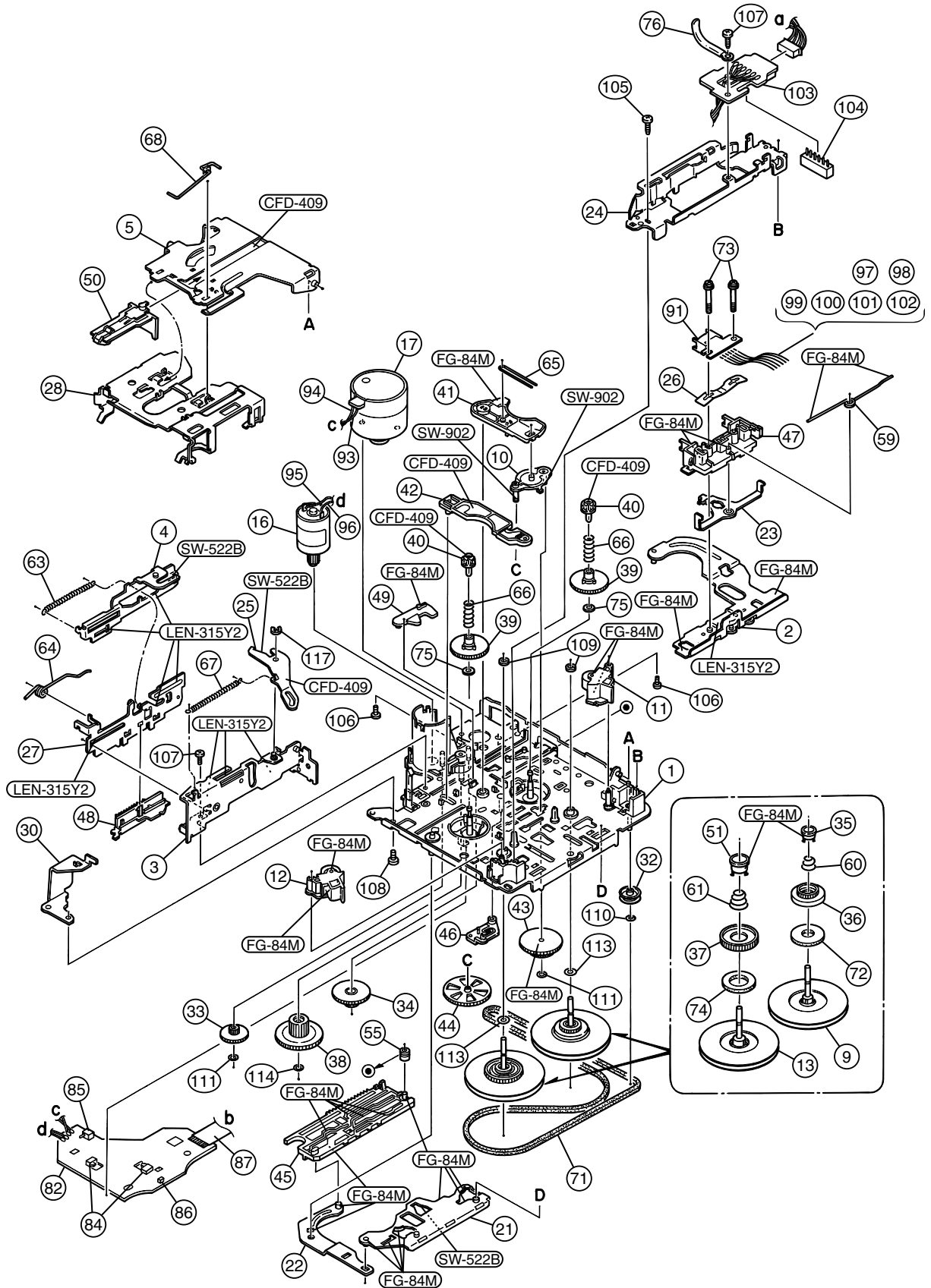

# Cassette mechanism assembly and parts list

CDS-801

Block No. M 2 M M



# Grease point 1/2

	SW-902
	SW-522B
	FG-84M
	CFD-409
	LEN-315Y2

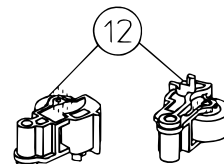
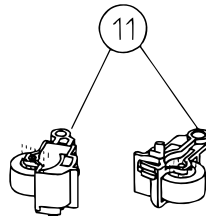
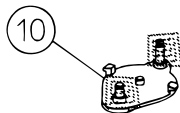
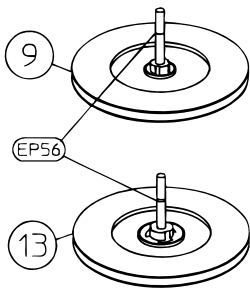
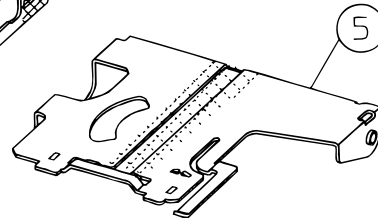
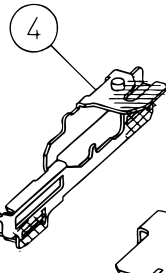
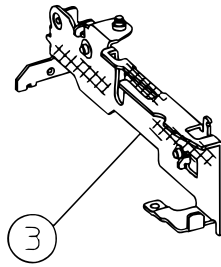
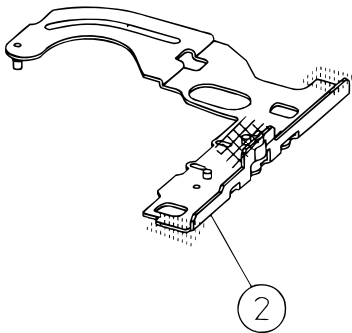
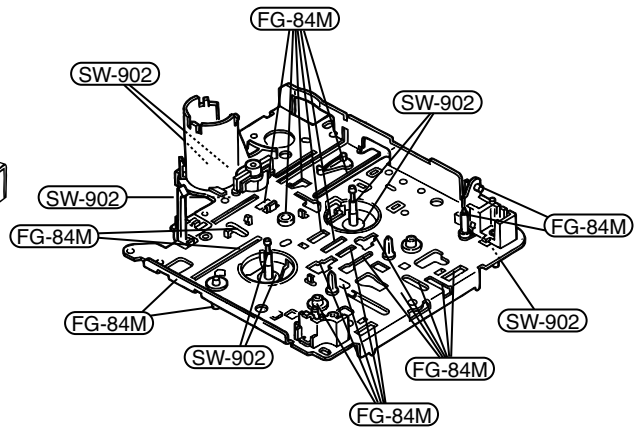
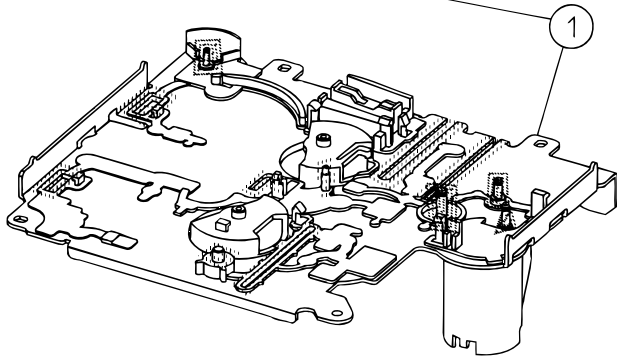
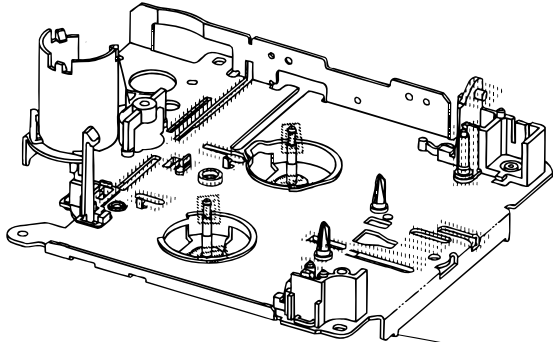

## Grease point 2/2

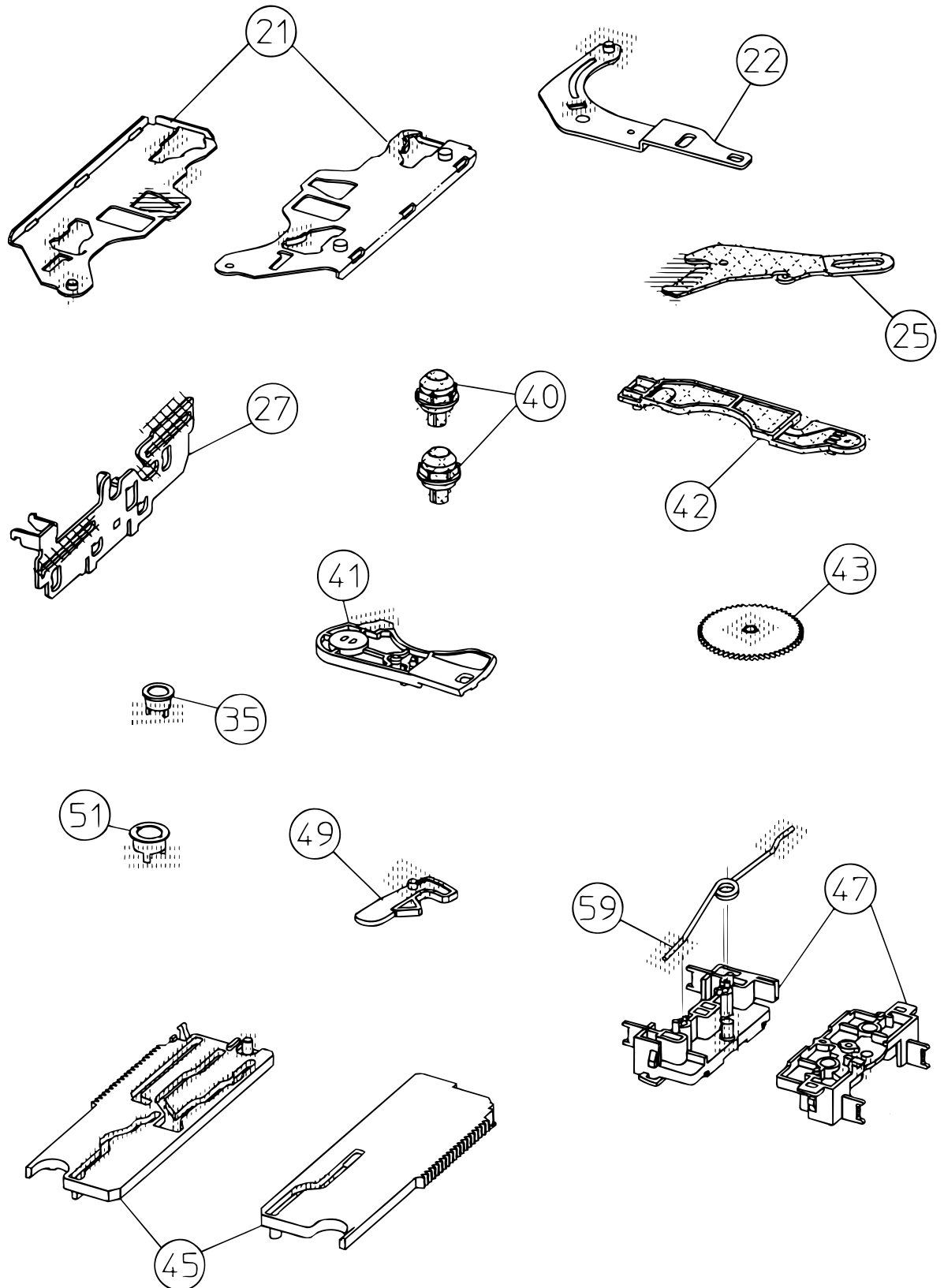

## ■ Parts list(Cassette mechanism)

Block No. M2MM

△	Item	Parts number	Parts name	Q'ty	Description	Area
	1	X-0801-1003S	MAIN CHASSIS AS	1		
	2	X-0801-1002S	SLIDE CHASSIS A	1		
	3	X-0801-1008S	SIDE BKT ASS'Y	1		
	4	X-0801-1010S	EJECT CAM LIMIT	1		
	5	X-0801-1013S	CASSETTE HANGER	1		
	9	1-0801-6002S	FLYWHEEL ASSY F	1		
	10	X-0801-2003S	GEAR BASE ASS'Y	1		
	11	X-0801-2021S	PINCH ARM F ASS	1		
	12	X-0801-2022S	PINCH ARM R ASS	1		
	13	1-0801-6003S	FLYWHEEL ASSY R	1		
	16	X-0801-7006S	SUB MOTOR ASS'Y	1		
	17	X-0801-7057S	MAIN MOTOR ASSY	1		
	21	1-0801-1003S	DIRECTION PLATE	1		
	22	1-0801-1004S	DIRECTION LINK	1		
	23	1-0801-1005S	PINCH SPG ARM	1		
	24	1-0801-1006S	CASSETTE GUIDE	1		
	25	1-0801-1007S	LOAD ARM	1		
	26	1-0801-1009S	HEAD SUPT SPG	1		
	27	1-0801-1011S	EJECT CAM PLATE	1		
	28	1-0801-1012S	CASSETTE HOLDER	1		
	30	1-0801-1020S	REINFORCE BRKT	1		
	32	1-0101-2056S	IDLE PULLEY(A1)	1		
	33	1-0801-2004S	REDUCTION GEARA	1		
	34	1-0801-2005S	REDUCTION GEARB	1		
	35	1-0801-2006S	SPG HOLDER F	1		
	36	1-0801-2007S	FRICTION GEARPL	1		
	37	1-0801-2008S	FRICTION GEARFF	1		
	38	1-0801-2009S	MODE GEAR	1		
	39	1-0801-2010S	REEL SPINDLE	2		
	40	1-0801-2011S	REEL DRIVER	2		
	41	1-0801-2014S	GEAR BASE ARM	1		
	42	1-0801-2015S	GEAR BASE LINK	1		
	43	1-0801-2016S	TAKE UP GEAR	1		
	44	1-0801-2017S	REFLECTOR GEAR	1		
	45	1-0801-2018S	MODE RACK	1		
	46	1-0801-2019S	MODE SW ACTUATR	1		
	47	1-0801-2020S	TAPE GUIDE	1		
	48	1-0801-2023S	LOAD RACK	1		
	49	1-0801-2024S	RACK LINK	1		
	50	1-0801-2025S	CASSETTE CATCH	1		
	51	1-0801-2030S	SPG HOLDER R	1		
	55	1-0801-3005S	RACK COLLAR	1		
	59	1-0801-4001S	PINCH ARM SPG	1		
	60	1-0801-4002S	TU SPG	1		
	61	1-0801-4003S	FF SPG	1		
	63	1-0801-4005S	EJECTCAM PLT SP	1		
	64	1-0801-4006S	HOLDER CUSH SPG	1		
	65	1-0801-4007S	GEAR BASE SPG	1		



**Parts list(Cassette mechanism)**

Block No. M2MM

△	Item	Parts number	Parts name	Q'ty	Description	Area
	66	1-0801-4008S	REEL DRIVER SPG	2		
	67	1-0801-4009S	LOAD ARM SPG	1		
	68	1-0801-4011S	HOLDER STAB SPG	1		
	71	1-0801-5001S	BELT	1		
	72	1-0801-5002S	FELT	1	7.5*18.5*1.0	
	73	1-0801-5003S	AZIMUTH SCR	2		
	74	1-0801-5004S	FELT	1	11*18.5*1.0	
	75	1-0801-5005S	REEL WASHER	2		
	76	21732-6280-36S	LUG PLATE	1		
	82	1-0801-7001S	REEL PCB DL	1		
	84	1-0801-7003S	SW(MATSUSHITA)	2	(ESE22MH2L)	
	85	1-0801-7005S	SW	1	(ALPS SPPB64)	
	86	1-0801-7024S	PHOTO SENSOR	1	(ON2170-QR FS)	
	87	1-0801-7026S	FLAT CABLE 10P	1		
	91	1-0801-7014S	HEAD	1	(MITSUMIP-5544)	
	93	10801-7009-0S	M.MOTOR WIRE	1	BLACK	
	94	10801-7009-1S	M.MOTOR WIRE	1	RED	
	95	10801-7010-0S	S.MOTOR WIRE	1	ORANGE	
	96	10801-7010-1S	S.MOTOR WIRE	1	BROWN	
	97	10801-7015-0S	HEAD WIRE BLACK	1		
	98	10801-7015-1S	HEAD WIRE BROWN	1		
	99	10801-7015-2S	HEAD WIRE RED	1		
	100	10801-7015-3S	HEAD WIRE ORANG	1		
	101	10801-7015-4S	HEAD WIRE YELLO	1		
	102	10801-7015-5S	HEAD WIRE WHITE	1		
	103	1-0801-7016S	HEAD PCB	1		
	104	1-0801-7025S	CONN S6B-PH-K-S	1		
	105	21382-3060-C2S	+PLAIN B-TYPE	1	M2.3*6.0	
	106	2-1032-0025-C2S	+SCREW PLAIN	2	M2*2.5	
	107	21332-0035-P1S	S-TYPE PRECISIO	2	M2*3.5	
	108	21112-6035-C2S	+SCREW PLAIN	1	M2.6*3.5	
	109	2-1816-0032-E8S	LMW-S	2	1.6*3.2*0.35	
	110	21812-0032-D2S	PSW-S	1	1.2*3.2*0.25	
	111	1-0036-5024S	PSW-S(REEL B)	2	1.5*3.2*0.25	
	113	2-1821-0040-D1S	PSW	2	2.1*4.0*0.25	
	114	21821-0040-D2S	PSW-S	1	2.1*4.0*0.25	
	117	2-1711-5040-16S	E-RING	1	1.5	

■ Electrical parts list(Main board)

Block No. 01

△	Item	Parts number	Parts name	Remarks	Area
	BZ841	QAN0009-001Z	BUZZER	KS-FX915R	
	C 1	QERF1CM-107Z	E CAPACITOR	100MF 20% 16V	
	C 2	NDC31HJ-470X	C CAPACITOR		
	C 3	NCB31EK-473X	C CAPACITOR		
	C 4	NCB31EK-104X	C CAPACITOR		
	C 5	QER41HM-105	E CAPACITOR	1.0MF 20% 50V	
	C 6	QER41HM-105	E CAPACITOR	1.0MF 20% 50V	
	C 7	QERF1HM-104Z	E CAPACITOR	.10MF 20% 50V	
	C 8	NDC31HJ-470X	C CAPACITOR		
	C 9	QER41AM-227	E CAPACITOR	220MF 20% 10V	
	C 31	NCB31EK-823X	C CAPACITOR		
	C 32	NCB31EK-823X	C CAPACITOR		
	C 33	NDC21HJ-151X	C CAPACITOR		
	C 41	NCB31HK-102X	C CAPACITOR		
	C 42	QEQF1HM-225Z	E CAPACITOR	2.2MF 20% 50V	
	C 43	QERF1HM-474Z	E CAPACITOR	.47MF 20% 50V	
	C 51	NDC31HJ-331X	C CAPACITOR		
	C 52	NCB31EK-103X	C CAPACITOR		
	C 53	NCB31HK-472X	C CAPACITOR		
	C 54	NCB31EK-104X	C CAPACITOR		
	C 55	QERF1HM-474Z	E CAPACITOR	.47MF 20% 50V	
	C 71	NCB31EK-223X	C CAPACITOR	KS-FX915R	
	C 72	NCB31HK-561X	C CAPACITOR	KS-FX915R	
	C 73	QERF1HM-225Z	E CAPACITOR	KS-FX915R	
	C 74	NDC31HJ-820X	C CAPACITOR	KS-FX915R	
	C 75	NDC31HJ-470X	C CAPACITOR	KS-FX915R	
	C 76	NCB31HK-103X	C CAPACITOR	KS-FX915R	
	C 77	QER41CM-476	E CAPACITOR	47MF 20% 16V	
	C 81	NCB31EK-183X	C CAPACITOR		
	C 82	NCB31HK-183X	C CAPACITOR		
	C 161	QERF1HM-225Z	E CAPACITOR	2.2MF 20% 50V	
	C 162	QER41HM-105	E CAPACITOR	1.0MF 20% 50V	
	C 163	QER41HM-105	E CAPACITOR	1.0MF 20% 50V	
	C 164	QER41HM-105	E CAPACITOR	1.0MF 20% 50V	
	C 165	QER41HM-105	E CAPACITOR	1.0MF 20% 50V	
	C 166	QERF1HM-225Z	E CAPACITOR	2.2MF 20% 50V	
	C 167	QER41CM-476	E CAPACITOR	47MF 20% 16V	
	C 168	QERF1CM-107Z	E CAPACITOR	100MF 20% 16V	
	C 169	NCB31HK-822X	C CAPACITOR		
	C 170	NCB21CK-154X	C CAPACITOR		
	C 171	NCB21CK-224X	C CAPACITOR		
	C 172	NCB31HK-822X	C CAPACITOR		
	C 173	NCB21CK-154X	C CAPACITOR		
	C 174	NCB21CK-224X	C CAPACITOR		
	C 175	NCB31EK-333X	C CAPACITOR		
	C 176	NCB31EK-333X	C CAPACITOR		
	C 177	NCB31HK-562X	C CAPACITOR		
	C 178	NCB31HK-562X	C CAPACITOR		
	C 180	QERF1CM-107Z	E CAPACITOR	100MF 20% 16V	
	C 181	QERF1HM-475Z	E CAPACITOR	4.7MF 20% 50V	
	C 182	QERF1HM-475Z	E CAPACITOR	4.7MF 20% 50V	
	C 183	QERF1HM-475Z	E CAPACITOR	4.7MF 20% 50V	
	C 184	QERF1HM-475Z	E CAPACITOR	4.7MF 20% 50V	
	C 241	QER41HM-105	E CAPACITOR	1.0MF 20% 50V	
	C 242	QERF1CM-226Z	E CAPACITOR	22MF 20% 16V	
	C 243	NCB31EK-473X	C CAPACITOR		
	C 244	QERF1HM-224Z	E CAPACITOR	.22MF 20% 50V	
	C 301	QERF1CM-475Z	E CAPACITOR	4.7MF 20% 16V	
	C 302	QER41CM-476	E CAPACITOR	47MF 20% 16V	
	C 303	NCS31HJ-391X	C CAPACITOR		
	C 304	NCS31HJ-391X	C CAPACITOR		
	C 305	NCB31EK-104X	C CAPACITOR		
	C 306	NCB31EK-104X	C CAPACITOR		

△	Item	Parts number	Parts name	Remarks	Area
	C 307	QERF1HM-475Z	E CAPACITOR	4.7MF 20% 50V	
	C 308	QERF1HM-225Z	E CAPACITOR	2.2MF 20% 50V	
	C 309	QERF1HM-225Z	E CAPACITOR	2.2MF 20% 50V	
	C 313	NCS31HJ-391X	C CAPACITOR		
	C 314	NCS31HJ-391X	C CAPACITOR		
	C 318	QERF1HM-225Z	E CAPACITOR	2.2MF 20% 50V	
	C 319	QERF1HM-225Z	E CAPACITOR	2.2MF 20% 50V	
	C 323	NCB31EK-104X	C CAPACITOR		
	C 324	NCB31EK-104X	C CAPACITOR		
	C 325	NCB31EK-104X	C CAPACITOR		
	C 326	NCB31EK-104X	C CAPACITOR		
	C 327	QERF1CM-226Z	E CAPACITOR	22MF 20% 16V	
	C 701	NCB31HK-102X	C CAPACITOR		
	C 702	NCB31EK-104X	C CAPACITOR		
	C 703	QER41AM-227	E CAPACITOR	220MF 20% 10V	
	C 704	QERF0JM-107Z	E CAPACITOR	100MF 20% 6.3V	
	C 705	NCB31EK-104X	C CAPACITOR		
	C 706	NDC21HJ-270X	C CAPACITOR		
	C 707	NDC21HJ-270X	C CAPACITOR		
	C 708	NCB31EK-104X	C CAPACITOR		
	C 709	NCB31EK-104X	C CAPACITOR		
	C 713	NCB31HK-102X	C CAPACITOR		
	C 781	QERF1CM-107Z	E CAPACITOR	100MF 20% 16V	
	C 782	QER41AM-227	E CAPACITOR	220MF 20% 10V	
	C 801	NCB31EK-473X	C CAPACITOR		
	C 841	QERF1HM-104Z	E CAPACITOR	KS-FX915R	
	C 881	NCB31EK-104X	C CAPACITOR	KS-FX915R	
	C 882	QERF1CM-226Z	E CAPACITOR	KS-FX915R	
	C 891	NCB31EK-104X	C CAPACITOR		
	C 901	QER41CM-106	E CAPACITOR	10MF 20% 16V	
	C 902	NCB31EK-473X	C CAPACITOR		
	C 903	QETB1CM-228	E CAPACITOR	2200MF 20% 16V	
	C 904	NCB31EK-473X	C CAPACITOR		
	C 905	QERF1HM-104Z	E CAPACITOR	.10MF 20% 50V	
	C 906	QERF1CM-107Z	E CAPACITOR	100MF 20% 16V	
	C 907	QER41HM-105	E CAPACITOR	1.0MF 20% 50V	
	C 908	QER41AM-227	E CAPACITOR	220MF 20% 10V	
	C 909	QETN0JM-228Z	E CAPACITOR	2200MF 20% 6.3V	
	C 911	NCS31HJ-151X	C CAPACITOR		
	C 981	NCB31EK-104X	C CAPACITOR		
	C 982	QER41CM-106	E CAPACITOR	10MF 20% 16V	
	CJ601	QNZ0007-002	CAR CONNECTOR		
	CP401	QGB1214J1-18S	CONNECTOR		
	CP901	QNZ0112-001	CAR CONNECTOR		
	D 2	1SS355-X	DIODE		
	D 3	1SS355-X	DIODE		
	D 4	1SS355-X	DIODE		
	D 5	1SS133-T2	SI DIODE		
	D 6	1SS133-T2	SI DIODE		
	D 7	1SS355-X	DIODE		
	D 161	1SS355-X	DIODE		
	D 162	1SS355-X	DIODE		
	D 241	1SS355-X	DIODE		
	D 242	1SS355-X	DIODE		
	D 323	1SS355-X	DIODE		
	D 333	1SS355-X	DIODE		
	D 343	1SS355-X	DIODE		
	D 353	1SS355-X	DIODE		
	D 701	MTZJ5.6B-T2	ZENER DIODE		
	D 702	MTZJ5.6B-T2	ZENER DIODE		
	D 703	MTZJ5.6B-T2	ZENER DIODE	KS-FX915R	
	D 704	MTZJ5.6B-T2	ZENER DIODE		
	D 705	MTZJ5.6B-T2	ZENER DIODE		

## ■ Electrical parts list(Main board)

Block No. 01

△	Item	Parts number	Parts name	Remarks	Area	△	Item	Parts number	Parts name	Remarks	Area
	D 706	MTZJ5.6B-T2	ZENER DIODE				Q 977	2SA1037AK/RS/-X	TRANSISTOR		
	D 707	MTZJ5.6B-T2	ZENER DIODE			R 1	NRS181J-330X	MG RESISTOR			
	D 708	MTZJ5.6B-T2	ZENER DIODE			R 2	NRSA63J-472X	MG RESISTOR			
	D 709	MTZJ5.6B-T2	ZENER DIODE			R 3	NRSA63J-473X	MG RESISTOR			
	D 710	MTZJ5.6B-T2	ZENER DIODE	KS-FX915R		R 4	NRSA63J-332X	MG RESISTOR			
	D 711	MTZJ5.6B-T2	ZENER DIODE			R 5	NRSA63J-473X	MG RESISTOR			
	D 712	SLR-56MC3F	LED			R 6	NRS181J-8R2X	MG RESISTOR			
	D 781	MTZJ11C-T2	Z.DIODE			R 8	NRSA63J-472X	MG RESISTOR			
	D 782	1SS355-X	DIODE			R 9	NRSA63J-472X	MG RESISTOR			
	D 783	1SS355-X	DIODE			R 10	NRSA63J-472X	MG RESISTOR			
	D 891	1SS355-X	DIODE			R 11	NRS181J-223X	MG RESISTOR			
	D 892	1SS355-X	DIODE			R 12	NRSA63J-0R0X	MG RESISTOR			
	D 901	1N5401-TU-15	DIODE			R 31	NRSA63J-102X	MG RESISTOR			
	D 902	1SS355-X	DIODE			R 32	NRSA63J-152X	MG RESISTOR			
	D 903	1SS355-X	DIODE			R 33	NRSA63J-102X	MG RESISTOR			
	D 981	CRS03-W	SB DIODE			R 34	NRSA63J-102X	MG RESISTOR			
	D 982	CRS03-W	SB DIODE			R 41	NRSA63J-152X	MG RESISTOR			
	IC 71	SAA6579T-X	IC	KS-FX915R		R 42	NRSA63J-102X	MG RESISTOR			
	IC161	TEA6320T-X	IC			R 43	NRSA63J-103X	MG RESISTOR			
	IC301	LA4743K	IC			R 44	NRS181J-102X	MG RESISTOR			
	IC701	UPD178018AGC604	I.C(MICRO-COMP)	KS-FX915R		R 53	NRSA63J-473X	MG RESISTOR			
	IC701	UPD178018AGC586	I.C(MICRO-COMP)	KS-FX815		R 54	NRSA63J-473X	MG RESISTOR			
	IC801	HD74HC126FP-X	IC			R 55	NRSA63J-103X	MG RESISTOR			
	IC901	HA13164	IC			R 56	NRSA63J-222X	MG RESISTOR			
	J 1	QNB0100-001	CAR ANT JACK			R 57	NRSA63J-103X	MG RESISTOR			
	J 321	QNN0175-001	PIN JACK			R 58	NRSA63J-153X	MG RESISTOR			
	J 801	QNZ0095-001	CONNECTOR			R 59	NRSA63J-471X	MG RESISTOR			
	L 1	QQL231K-4R7Y	INDUCTOR			R 60	NRSA63J-473X	MG RESISTOR			
	L 901	QQR0703-001	CHOKE COIL			R 71	NRSA63J-222X	MG RESISTOR	KS-FX915R		
	L 902	QQL231K-470Y	INDUCTOR			R 72	NRSA02J-222X	MG RESISTOR	KS-FX915R		
	L 903	QQL231K-470Y	INDUCTOR			R 73	NRSA02J-222X	MG RESISTOR	KS-FX915R		
	Q 1	DTC114EKA-X	TRANSISTOR			R 81	NRSA63J-103X	MG RESISTOR			
	Q 2	2SA1037AK/RS/-X	TRANSISTOR			R 82	NRSA63J-103X	MG RESISTOR			
	Q 3	2SA1037AK/RS/-X	TRANSISTOR			R 83	NRSA63J-223X	MG RESISTOR			
	Q 4	DTA114EKA-X	DIGITAL.TRANSIS			R 84	NRSA63J-223X	MG RESISTOR			
	Q 5	DTA114EKA-X	DIGITAL.TRANSIS			R 161	NRSA63J-0R0X	MG RESISTOR			
	Q 6	2SC2412K/R/-X	TRANSISTOR			R 162	NRSA63J-0R0X	MG RESISTOR			
	Q 7	2SC2412K/R/-X	TRANSISTOR			R 165	NRSA63J-223X	MG RESISTOR			
	Q 8	2SC2412K/R/-X	TRANSISTOR			R 166	NRSA63J-222X	MG RESISTOR			
	Q 9	DTC114EKA-X	TRANSISTOR			R 167	NRSA63J-223X	MG RESISTOR			
	Q 10	DTA114EKA-X	DIGITAL.TRANSIS			R 168	NRSA63J-222X	MG RESISTOR			
	Q 31	2SC3661-X	TRANSISTOR			R 169	NRSA63J-224X	MG RESISTOR			
	Q 32	2SC3661-X	TRANSISTOR			R 170	NRSA63J-224X	MG RESISTOR			
	Q 41	2SC2412K/R/-X	TRANSISTOR			R 171	NRS181J-100X	MG RESISTOR			
	Q 42	2SC2412K/R/-X	TRANSISTOR			R 172	NRSA63J-271X	MG RESISTOR			
	Q 51	2SC2412K/R/-X	TRANSISTOR			R 173	NRSA63J-271X	MG RESISTOR			
	Q 52	2SC2412K/R/-X	TRANSISTOR			R 241	NRSA63J-473X	MG RESISTOR			
	Q 53	DTC114EKA-X	TRANSISTOR			R 242	NRSA63J-184X	MG RESISTOR			
	Q 241	2SD601A/R/-X	TRANSISTOR			R 243	NRSA63J-123X	MG RESISTOR			
	Q 321	2SD1048/6-7/-X	TRANSISTOR			R 244	NRSA63J-223X	MG RESISTOR			
	Q 331	2SD1048/6-7/-X	TRANSISTOR			R 245	NRSA02J-101X	MG RESISTOR			
	Q 341	2SD1048/6-7/-X	TRANSISTOR			R 246	NRSA02J-102X	MG RESISTOR			
	Q 351	2SD1048/6-7/-X	TRANSISTOR			R 247	NRSA63J-683X	MG RESISTOR			
	Q 701	2SC2412K/R/-X	TRANSISTOR			R 301	NRSA63J-273X	MG RESISTOR			
	Q 781	DTA114EKA-X	DIGITAL.TRANSIS			R 302	NRSA63J-273X	MG RESISTOR			
	Q 782	DTA114EKA-X	DIGITAL.TRANSIS			R 305	NRSA63J-102X	MG RESISTOR			
	Q 784	DTC114EKA-X	TRANSISOR			R 306	NRSA63J-473X	MG RESISTOR			
	Q 841	DTC114EKA-X	TRANSISOR	KS-FX915R		R 307	NRSA63J-473X	MG RESISTOR			
	Q 881	DTC114EKA-X	TRANSISOR	KS-FX915R		R 308	NRSA63J-473X	MG RESISTOR			
	Q 891	UN2211-X	TRANSISTOR			R 309	NRSA63J-473X	MG RESISTOR			
	Q 901	DTC114EKA-X	TRANSISTOR			R 311	NRSA63J-273X	MG RESISTOR			
	Q 902	2SA1706/ST-T	TRANSISTOR			R 312	NRSA63J-273X	MG RESISTOR			
	Q 976	UN2211-X	TRANSISTOR			R 321	NRS181J-101X	MG RESISTOR			

■ Electrical parts list(Main board)

Block No. 01

▲	Item	Parts number	Parts name	Remarks	Area
	R 322	NRSA63J-102X	MG RESISTOR		
	R 323	NRS181J-222X	MG RESISTOR		
	R 331	NRSA63J-101X	MG RESISTOR		
	R 332	NRSA63J-102X	MG RESISTOR		
	R 333	NRS181J-222X	MG RESISTOR		
	R 341	NRSA63J-101X	MG RESISTOR		
	R 342	NRSA63J-102X	MG RESISTOR		
	R 343	NRSA63J-222X	MG RESISTOR		
	R 351	NRS181J-101X	MG RESISTOR		
	R 352	NRSA63J-102X	MG RESISTOR		
	R 353	NRSA63J-222X	MG RESISTOR		
	R 701	NRSA63J-0R0X	MG RESISTOR		
	R 702	NRSA63J-0R0X	MG RESISTOR		
	R 703	NRSA63J-0R0X	MG RESISTOR		
	R 704	NRSA63J-103X	MG RESISTOR		
	R 705	NRSA63J-103X	MG RESISTOR		
	R 706	NRSA63J-103X	MG RESISTOR	KS-FX915R	
	R 707	NRSA63J-472X	MG RESISTOR		
	R 708	NRSA63J-472X	MG RESISTOR		
	R 709	NRSA63J-473X	MG RESISTOR	KS-FX815	
	R 711	NRSA63J-473X	MG RESISTOR		
	R 712	NRSA63J-473X	MG RESISTOR		
	R 713	NRSA63J-103X	MG RESISTOR		
	R 714	NRSA63J-472X	MG RESISTOR		
	R 715	NRSA63J-472X	MG RESISTOR		
	R 716	NRSA63J-472X	MG RESISTOR		
	R 717	NRSA63J-472X	MG RESISTOR		
	R 718	NRSA63J-103X	MG RESISTOR		
	R 719	NRSA63J-103X	MG RESISTOR		
	R 720	NRSA63J-103X	MG RESISTOR		
	R 721	NRS181J-103X	MG RESISTOR		
	R 722	NRSA63J-103X	MG RESISTOR		
	R 723	NRSA63J-472X	MG RESISTOR		
	R 724	NRSA63J-472X	MG RESISTOR		
	R 725	NRSA63J-472X	MG RESISTOR		
	R 726	NRSA63J-472X	MG RESISTOR		
	R 727	NRSA63J-472X	MG RESISTOR		
	R 728	NRSA63J-472X	MG RESISTOR		
	R 729	NRSA63J-473X	MG RESISTOR		
	R 730	NRSA63J-391X	MG RESISTOR		
	R 731	NRSA63J-103X	MG RESISTOR		
	R 732	NRSA63J-473X	MG RESISTOR		
	R 733	NRSA63J-473X	MG RESISTOR		
	R 735	NRSA63J-473X	MG RESISTOR		
	R 738	NRSA63J-473X	MG RESISTOR		
	R 739	NRSA63J-104X	MG RESISTOR		
	R 740	NRSA63J-473X	MG RESISTOR	KS-FX815	
	R 741	NRSA63J-473X	MG RESISTOR	KS-FX915R	
	R 742	NRSA63J-563X	MG RESISTOR		
	R 743	NRSA63J-473X	MG RESISTOR		
	R 744	NRSA63J-103X	MG RESISTOR	KS-FX915R	
	R 745	NRSA63J-473X	MG RESISTOR		
	R 747	NRSA63J-473X	MG RESISTOR		
	R 748	NRSA63J-243X	MG RESISTOR		
	R 749	NRSA63J-101X	MG RESISTOR		
	R 750	NRSA63J-473X	MG RESISTOR	KS-FX815	
	R 751	NRSA63J-473X	MG RESISTOR	KS-FX815	
	R 752	NRS181J-511X	MG RESISTOR		
	R 781	NRSA63J-472X	MG RESISTOR		
	R 782	NRSA63J-473X	MG RESISTOR		
	R 801	NRSA63J-104X	MG RESISTOR		
	R 802	NRSA63J-334X	MG RESISTOR		
	R 803	NRSA63J-101X	MG RESISTOR		

▲	Item	Parts number	Parts name	Remarks	Area
	R 804	NRSA63J-223X	MG RESISTOR		
	R 805	NRSA63J-104X	MG RESISTOR		
	R 806	NRSA63J-103X	MG RESISTOR		
	R 807	NRSA63J-104X	MG RESISTOR		
	R 808	NRSA63J-104X	MG RESISTOR		
	R 809	NRSA63J-101X	MG RESISTOR		
	R 810	NRSA63J-334X	MG RESISTOR		
	R 841	NRSA63J-102X	MG RESISTOR	KS-FX915R	
	R 842	NRSA02J-222X	MG RESISTOR	KS-FX915R	
	R 881	NRSA63J-473X	MG RESISTOR	KS-FX915R	
	R 882	NRSA63J-472X	MG RESISTOR	KS-FX915R	
	R 891	NRSA02J-473X	MG RESISTOR		
	R 892	NRSA02J-102X	MG RESISTOR		
	R 901	QRE141J-470Y	C RESISTOR	47 5% 1/4W	
	R 902	NRS181J-103X	MG RESISTOR		
	R 903	NRS181J-472X	MG RESISTOR		
	R 904	NRS181J-183X	MG RESISTOR		
	R 905	NRS181J-103X	MG RESISTOR		
	R 906	NRS181J-102X	MG RESISTOR		
	R 907	NRS181J-473X	MG RESISTOR		
	R 976	NRSA63J-104X	MG RESISTOR		
	R 977	NRSA63J-273X	MG RESISTOR		
	R 978	NRS181J-123X	MG RESISTOR		
	S 701	QSW0451-001	DETECT SW		
	S 702	QSW0451-001	DETECT SW		
	S 703	QSQ1A11-V06Z	TACT SW		
	TU 1	QAU0221-001	TUNER		
	X 71	QAX0263-001Z	CRYSTAL	KS-FX915R	
	X 701	QAX0406-002Z	CRYSTAL		

**■ Electrical parts list(Mecha control board) Block No. 02**

△	Item	Parts number	Parts name	Remarks	Area
	C 401	NDC31HJ-101X	C.CAPACITOR		
	C 402	NDC31HJ-101X	C.CAPACITOR		
	C 403	NDC31HJ-101X	C.CAPACITOR		
	C 404	NDC31HJ-101X	C.CAPACITOR		
	C 405	NDC31HJ-101X	C.CAPACITOR		
	C 406	NDC31HJ-101X	C.CAPACITOR		
	C 407	NDC31HJ-101X	C.CAPACITOR		
	C 408	NDC31HJ-101X	C.CAPACITOR		
	C 409	QEKJ1CM-226Z	E CAPACITOR	22MF 20% 16V	
	C 410	QFV61HJ-153Z	MF CAPACITOR	.015MF 5% 50V	
	C 411	QFV61HJ-153Z	MF CAPACITOR	.015MF 5% 50V	
	C 412	NCB31EK-104X	C CAPACITOR		
	C 413	NCB31EK-104X	C CAPACITOR		
	C 414	QEKJ1CM-226Z	E CAPACITOR	22MF 20% 16V	
	C 416	QFV61HJ-104Z	MF CAPACITOR	DOLBY	
	C 417	QFV61HJ-104Z	MF CAPACITOR	DOLBY	
	C 418	NDC31HJ-221X	C CAPACITOR		
	C 419	QEK41HM-474	E CAPACITOR	.47MF 20% 50V	
	C 421	NCB31HK-103X	C CAPACITOR		
	C 422	NCB31EK-104X	C CAPACITOR		
	C 423	QER41CM-106	E CAPACITOR	10MF 20% 16V	
	C 424	NCB31EK-104X	C CAPACITOR		
	C 425	NCB31HK-103X	C CAPACITOR		
	CN401	QGB1214K1-18S	CONNECTOR		
	CN402	VMP3501-001	CONNECTOR		
	CN403	QGF1219F1-10S	CONNECTOR		
	D 401	MA3047/H/-X	DIODE		
	D 402	DSK10C-T1	DIODE		
	IC401	CXA2560Q	IC		
	IC402	LB1641	IC		
	Q 402	DTC114EKA-X	TRANSISOR		
	Q 403	2SB1322/RS/-T	TRANSISTOR		
	R 401	NRS181J-391X	MG RESISTOR		
	R 402	NRSA63J-104X	MG RESISTOR		
	R 403	NRSA63J-104X	MG RESISTOR		
	R 404	NRSA63J-104X	MG RESISTOR		
	R 405	NRSA63J-104X	MG RESISTOR		
	R 406	NRSA63J-181X	MG RESISTOR		
	R 407	NRSA63J-181X	MG RESISTOR		
	R 412	NRSA02J-101X	MG RESISTOR		
	R 413	NRSA63J-183X	MG RESISTOR		
	R 414	NRSA63J-392X	MG RESISTOR		
	R 415	NRSA63J-223X	MG RESISTOR		
	R 416	NRSA63J-914X	MG RESISTOR		
	R 417	NRSA63J-103X	MG RESISTOR		
	R 418	NRSA63J-153X	MG RESISTOR		
	R 422	NRSA02J-332X	MG RESISTOR		
	R 423	NRS181J-473X	MG RESISTOR		
	R 424	NRSA02J-332X	MG RESISTOR		
	R 425	NRS181J-330X	MG RESISTOR		
	R 426	QUY150-050Y	BUS WIRE		
	VR401	QVP0009-333Z	SEMI V RESISTOR	DOLBY	
	VR402	QVP0009-333Z	SEMI V RESISTOR	DOLBY	

## ■ Electrical parts list(Front board)

Block No. 03

△	Item	Parts number	Parts name	Remarks	Area	△	Item	Parts number	Parts name	Remarks	Area
	C 601	NBE20JM-475X	TS E CAPACITOR				D 655	1SS355-X	DIODE		
	C 602	NCB31HK-103X	C CAPACITOR				D 656	1SS355-X	DIODE		
	C 603	NCS31HJ-221X	C CAPACITOR				D 657	UDZS5.6B-X	Z DIODE	KS-FX915R	
	C 604	NCB31AK-224X	C CAPACITOR				D 658	1SS355-X	DIODE		
	C 605	NCB31AK-224X	C CAPACITOR				D 659	1SS355-X	DIODE		
	C 606	NBE20JM-475X	TS E CAPACITOR	KS-FX915R			EN601	QSW0928-001	ROTARY SWITCH	KS-FX815	
	CN601	QNZ0006-001	CAR CONNECTOR				EN601	QSW0863-001	ROTARY SWITCH	KS-FX915R	
	D 601	SML-310LT/MN/-X	LED				IC601	LC75873NW	IC		
	D 602	SML-310VT/JK/-X	LED	KS-FX915R			IC602	RPM6938-SV4	IC	KS-FX915R	
	D 602	LNJ308G81/1-3/X	LED	KS-FX815			Q 641	2SB815/7/-X	TRANSISTOR	KS-FX915R	
	D 603	LNJ308G81/1-3/X	LED	KS-FX815			Q 642	UN2211-X	TRANSISTOR	KS-FX915R	
	D 603	SML-310VT/JK/-X	LED	KS-FX915R			R 601	NRSA63J-821X	MG RESISTOR		
	D 604	SML-310VT/JK/-X	LED	KS-FX915R			R 602	NRSA63J-821X	MG RESISTOR		
	D 604	LNJ308G81/1-3/X	LED	KS-FX815			R 603	NRSA63J-122X	MG RESISTOR		
	D 605	SML-310VT/JK/-X	LED	KS-FX915R			R 604	NRSA63J-182X	MG RESISTOR		
	D 605	LNJ308G81/1-3/X	LED	KS-FX815			R 605	NRSA63J-272X	MG RESISTOR		
	D 606	LNJ308G81/1-3/X	LED	KS-FX815			R 606	NRSA63J-821X	MG RESISTOR		
	D 606	SML-310VT/JK/-X	LED	KS-FX915R			R 607	NRSA63J-821X	MG RESISTOR		
	D 607	SML-310VT/JK/-X	LED	KS-FX915R			R 608	NRSA63J-122X	MG RESISTOR		
	D 607	LNJ308G81/1-3/X	LED	KS-FX815			R 609	NRSA63J-182X	MG RESISTOR		
	D 608	LNJ308G81/1-3/X	LED	KS-FX815			R 611	NRSA63J-272X	MG RESISTOR		
	D 608	SML-310VT/JK/-X	LED	KS-FX915R			R 612	NRSA63J-821X	MG RESISTOR		
	D 609	SML-310VT/JK/-X	LED	KS-FX915R			R 613	NRSA63J-821X	MG RESISTOR		
	D 609	LNJ308G81/1-3/X	LED	KS-FX815			R 614	NRSA63J-122X	MG RESISTOR		
	D 610	SML-310VT/JK/-X	LED	KS-FX915R			R 615	NRSA63J-182X	MG RESISTOR		
	D 610	LNJ308G81/1-3/X	LED	KS-FX815			R 616	NRSA63J-272X	MG RESISTOR		
	D 611	LNJ308G81/1-3/X	LED	KS-FX815			R 617	NRSA63J-392X	MG RESISTOR		
	D 611	SML-310VT/JK/-X	LED	KS-FX915R			R 620	NRS181J-471X	MG RESISTOR		
	D 612	SML-310VT/JK/-X	LED	KS-FX915R			R 621	NRS181J-271X	MG RESISTOR		
	D 612	LNJ308G81/1-3/X	LED	KS-FX815			R 622	NRS181J-271X	MG RESISTOR		
	D 613	SML-310VT/JK/-X	LED	KS-FX915R			R 623	NRS181J-271X	MG RESISTOR		
	D 613	LNJ308G81/1-3/X	LED	KS-FX815			R 624	NRS181J-391X	MG RESISTOR		
	D 614	LNJ308G81/1-3/X	LED	KS-FX815			R 625	NRS181J-431X	MG RESISTOR		
	D 614	SML-310VT/JK/-X	LED	KS-FX915R			R 626	NRS181J-271X	MG RESISTOR		
	D 615	SML-310VT/JK/-X	LED	KS-FX915R			R 627	NRS181J-391X	MG RESISTOR		
	D 615	LNJ308G81/1-3/X	LED	KS-FX815			R 628	NRS181J-561X	MG RESISTOR		
	D 616	LNJ308G81/1-3/X	LED	KS-FX815			R 629	NRS181J-511X	MG RESISTOR		
	D 616	SML-310VT/JK/-X	LED	KS-FX915R			R 630	NRS181J-511X	MG RESISTOR		
	D 617	SML-310VT/JK/-X	LED	KS-FX915R			R 641	NRS181J-102X	MG RESISTOR	KS-FX815	
	D 617	LNJ308G81/1-3/X	LED	KS-FX815			R 641	NRS181J-471X	MG RESISTOR	KS-FX915R	
	D 618	LNJ308G81/1-3/X	LED	KS-FX815			R 642	NRS181J-471X	MG RESISTOR	KS-FX915R	
	D 618	SML-310VT/JK/-X	LED	KS-FX915R			R 642	NRS181J-102X	MG RESISTOR	KS-FX815	
	D 619	SML-310VT/JK/-X	LED	KS-FX915R			R 643	NRS181J-102X	MG RESISTOR	KS-FX815	
	D 619	LNJ308G81/1-3/X	LED	KS-FX815			R 643	NRS181J-471X	MG RESISTOR	KS-FX915R	
	D 620	LNJ308G81/1-3/X	LED	KS-FX815			R 644	NRS181J-471X	MG RESISTOR	KS-FX915R	
	D 620	SML-310VT/JK/-X	LED	KS-FX915R			R 644	NRS181J-0R0X		KS-FX815	
	D 621	LNJ308G81/1-3/X	LED	KS-FX915R			R 645	NRSA63J-473X	MG RESISTOR	KS-FX915R	
	D 621	SML-310VT/JK/-X	LED	KS-FX815			R 646	NRS181J-102X	MG RESISTOR	KS-FX915R	
	D 622	SML-310VT/JK/-X	LED	KS-FX915R			R 650	NRSA02J-101X	MG RESISTOR		
	D 622	LNJ308G81/1-3/X	LED	KS-FX815			R 651	NRSA63J-473X	MG RESISTOR		
	D 623	LNJ308G81/1-3/X	LED	KS-FX815			R 652	NRSA63J-473X	MG RESISTOR		
	D 623	SML-310VT/JK/-X	LED	KS-FX915R			R 653	NRS181J-102X	MG RESISTOR		
	D 628	SML-310VT/JK/-X	LED	KS-FX915R			R 654	NRSA02J-221X	MG RESISTOR		
	D 628	LNJ308G81/1-3/X	LED	KS-FX815			R 655	NRSA02J-394X	MG RESISTOR		
	D 629	LNJ308G81/1-3/X	LED	KS-FX815			R 656	NRSA63J-334X	MG RESISTOR		
	D 629	SML-310VT/JK/-X	LED	KS-FX915R			R 657	NRSA63J-103X	MG RESISTOR	KS-FX915R	
	D 641	NSPW310BS/BRS/	LED				R 658	NRSA63J-470X	MG RESISTOR	KS-FX915R	
	D 642	NSPW310BS/BQ/	LED				R 661	NRSA63J-332X	MG RESISTOR		
	D 643	NSPW310BS/BRS/	LED				R 662	NRSA63J-332X	MG RESISTOR		
	D 651	UDZS5.1B-X	Z DIODE				R 663	NRSA63J-332X	MG RESISTOR		
	D 652	1SS355-X	DIODE				R 669	NRSA63J-103X	MG RESISTOR		
	D 653	1SS355-X	DIODE				R 670	NRSA63J-103X	MG RESISTOR		
	D 654	1SS355-X	DIODE				R 671	NRSA63J-103X	MG RESISTOR		

## ■ Electrical parts list(Front board)

Block No. 03





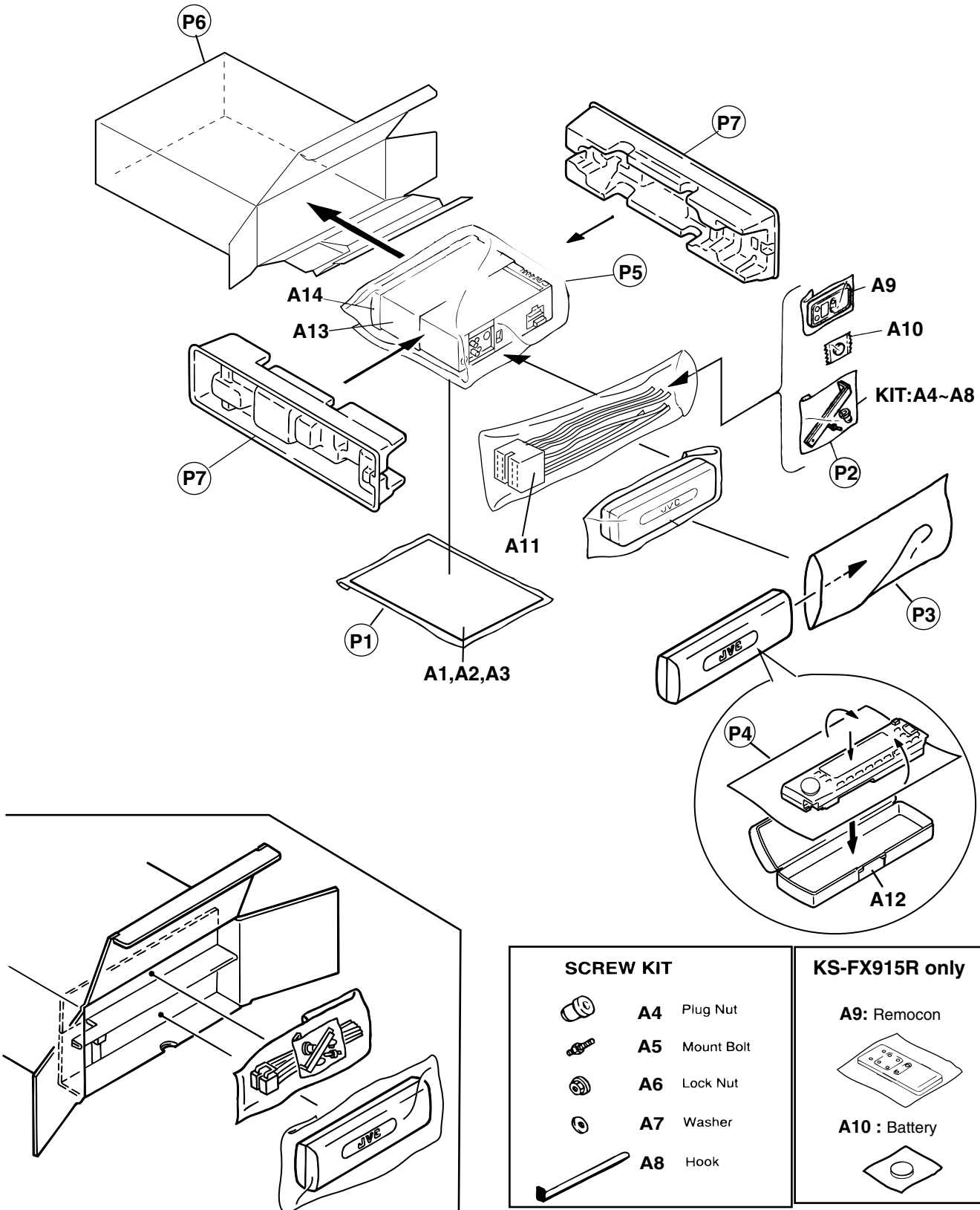

△	Item	Parts number	Parts name	Remarks	Area
	S 601	NSW0066-001X	TACT SWITCH		
	S 602	NSW0066-001X	TACT SWITCH		
	S 603	NSW0066-001X	TACT SWITCH		
	S 604	NSW0066-001X	TACT SWITCH		
	S 605	NSW0066-001X	TACT SWITCH		
	S 606	NSW0066-001X	TACT SWITCH		
	S 607	NSW0066-001X	TACT SWITCH		
	S 608	NSW0066-001X	TACT SWITCH		
	S 609	NSW0066-001X	TACT SWITCH		
	S 610	NSW0066-001X	TACT SWITCH		
	S 611	NSW0066-001X	TACT SWITCH		
	S 613	NSW0066-001X	TACT SWITCH		
	S 614	NSW0066-001X	TACT SWITCH		
	S 615	NSW0066-001X	TACT SWITCH		
	S 616	NSW0066-001X	TACT SWITCH		
	S 617	NSW0066-001X	TACT SWITCH		
	S 618	NSW0066-001X	TACT SWITCH		
	S 619	NSW0066-001X	TACT SWITCH		
	S 620	NSW0066-001X	TACT SWITCH		

# Packing materials and accessories parts list

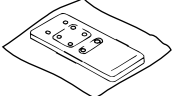
Block No. **M** **3** **M** **M**

Block No. **M** **4** **M** **M**



SCREW KIT		KS-FX915R only
	<b>A4</b> Plug Nut	<b>A9:</b> Remocon 
	<b>A5</b> Mount Bolt	<b>A10 :</b> Battery 
	<b>A6</b> Lock Nut	
	<b>A7</b> Washer	
	<b>A8</b> Hook	



## ■ Parts list(Packing)

Block No. M3MM

△	Item	Parts number	Parts name	Q'ty	Description	Area
	P 1	FSPG4002-001	POLY BAG	1	FOR INST. BOOK	
	P 2	QPA00801205	POLY BAG	1		
	P 3	QPA01003003	POLY BAG	1		
	P 4	FSYH4036-068	SHEET	1	FOR HARD CASE	
	P 5	QPC03004315P	POLY BAG	1	FOR SET	
	P 6	GE30123-013A	PACKING CASE	1	KS-FX815	
		GE30123-014A	PACKING CASE	1	KS-FX915R	
	P 7	GE10008-001A	EPS CUSHION	2		

## ■ Parts list(Accessories)

Block No. M4MM

△	Item	Parts number	Parts name	Q'ty	Description	Area
	A 1	GET0018-001A	INST BOOK	1	ENG RUS	
	A 2	GET0018-002A	INST BOOK	1	ENG RUS	
	A 3	BT-54013-1	WARRANTY CARD	1		
	A 4	VKZ4027-202	PLUG NUT	1		
	A 5	VKH4871-001SS	MOUNT BOLT	1		
	A 6	VKZ4328-001	LOCK NUT	1		
	A 7	WNS5000Z	WASHER	1		
	A 8	FSKL4010-002	HOOK	2		
	A 9	RM-RK31	REMOCON	1	KS-FX915R	
	A 10	-----	BATTERY	1	KS-FX915R	
	A 11	QAM0176-001	CAR CABLE	1	KS-FX915R	
		QAM0175-001	CAR CABLE	1	KS-FX815	
	A 12	FSJB3001-30C	HARD CASE	1		
	A 13	FSKM2004-202	MOUNTING SLEEVE	1		
	A 14	FSJD2034-001	TRIM PLATE	1		
	K I T	KDGS717K-SCREW1	SCREW PARTS KIT	1	A4-A8	